

Datasheet
4502701

Nusolar Akku-Solarleuchte 340mm anthrazit



Additional information:

Material/Surface : Aluminum powder coated for outdoor use.
 High power solar panel monocrystalline 140x140mm
 Lighting time = up to 3h at 100% light output, 25h at 15% light output
 Battery = Li-Ion with 2.200mAh capacity
 Regulation = detection range movement 6m - light output 100% , after 30 seconds without movement light output 15% , on/off at 20 lux
 Weight = 1,960g
 Scope of delivery = Light incl. ground spike.



Dimmable no

151 lm	luminous flux [lm]
2,20 Watt	rated power
2700 K	colour temperature
Ra>85	colour rendering
<5 sdcM	colour consistency
74°	beam angle
anthrazit	Colour housing
IP54	type of protection
-20° - 40°C	temperature range in operation
5 V AC	power factor
Hz	voltage
1 mA	operating frequency
3 kWh/1000h	current
<1.0 s	energy consumption
<0.5 s	warm-up time up to 60% of the full light output
	starting time
Ø 25.000 h	nominal life time
L70B50	rated life time L70/B50
0.7	lumen maintenance factor at the end of the nominal life

Spectral power distribution
in the range 180 - 800 nm

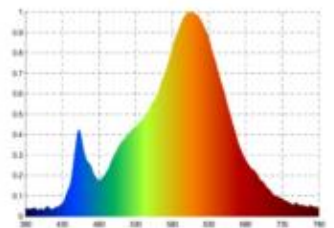

4502701

Nusolar Akku-Solarleuchte 340mm anthrazit

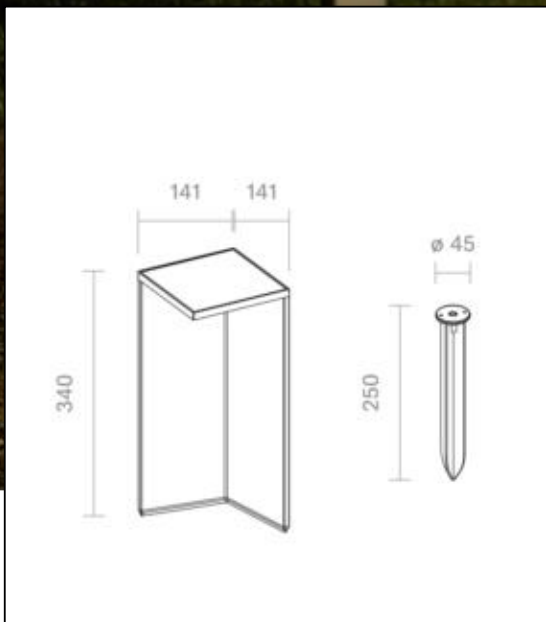

Manual:

https://shop.sigor.de/media/pdf/4502701_manual.pdf

as of: 22.08.2023

Page: 2

