

Datasheet
4515701

Akku-Solarleuchte Numove 525mm graphitgrau

It appears so light and delicate that you hardly notice its technical refinements: The outdoor lamp Numove can be charged by solar panel or plug, switches on automatically at dusk and is infinitely dimmable. With its integrated carrying handle and foldable wall hook, it provides a warm light in many places.



Dimmable: yes

Recommended dimmer: www.sigor.de/dimmerliste

172 lm	luminous flux [lm]
2,20 Watt	rated power
2700 K	colour temperature
Ra>85	colour rendering
<5 sdcms	colour consistency
120°	beam angle

graphitgrau	Colour housing
IP54	type of protection
-20° - 40°C	temperature range in operation

5 V AC	power factor
Hz	voltage
1 mA	operating frequency
3 kWh/1000h	current
<1.0 s	energy consumption
<0.5 s	warm-up time up to 60% of the full light output
	starting time

Ø 25.000 h	nominal life time
L70B50	rated life time L70/B50
0.7	lumen maintenance factor at the end of the nominal life

Spectral power distribution
in the range 180 - 800 nm

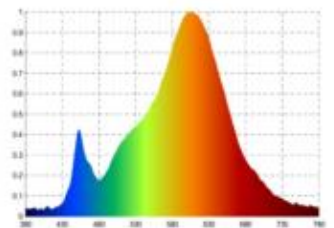

4515701

Akku-Solarleuchte Numove 525mm graphitgrau

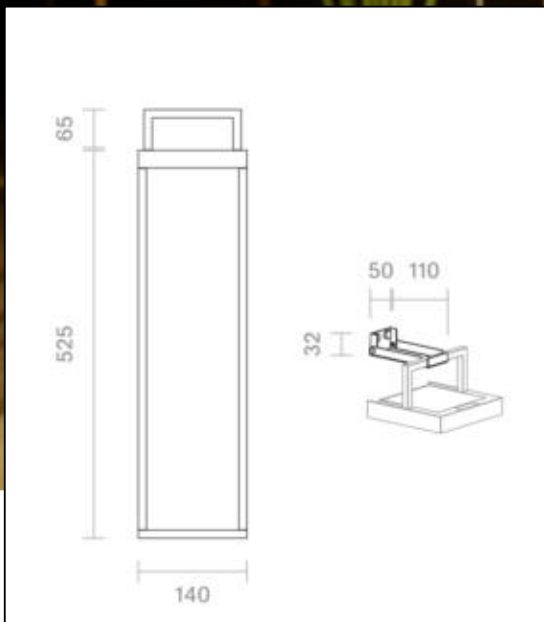

Manual:

https://shop.sigor.de/media/pdf/4515701_manual.pdf

as of: 22.08.2023

Page: 2