

Datasheet
4811201

Nivo Einbauleuchte schwenkbar 111mm 50° schwarz

A novel form of lighting: The Nivo® luminaire series offers uniform high-precision illumination with a clearly defined beam angle and a gently tapering light cone. The key to this innovation lies in an advanced High-Tech hybrid lens, which serves as the core of the luminaire series. It operates on an innovative optical principle that optimally combines the physical phenomena of refraction and reflection. Precisely calculated micro facets redirect the light rays before they exit, ensuring even, streak-free light distribution. This results in a pleasing, glare-free light with natural shadows. The lens's facets form an organically inspired ornament, providing an exquisite contrast to the minimalist design. Thanks to its wide range of variations, a suitable solution can be found for any application within the object. Those in search of a sophisticated lighting solution that excels in both aesthetics and functionality while boasting exceptional durability will discover an appealing new alternative in the Nivo® luminaire series.



Dimmable: yes

Recommended dimmer: www.sigor.de/dimmerliste

950 lm	luminous flux [lm]
14,00 Watt	rated power
3000-1800 K	colour temperature
Ra>90	colour rendering
3 sdcm	colour consistency
50°	beam angle

schwarz	Colour housing
IP30	type of protection
0° - 30°C	temperature range in operation

0,9	power factor
220-240 V AC	voltage
50-60 Hz	operating frequency
71 mA	current
14 kWh/1000h	energy consumption
0,2 s	warm-up time up to 60% of the full light output
0,1 s	starting time

Ø 50.000 h	nominal life time
L80B10	rated life time L70/B50
	lumen maintenance factor at the end of the nominal life

Spectral power distribution
in the range 180 - 800 nm

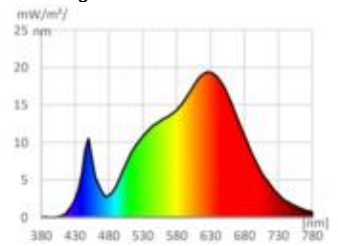

www.sigor.de

LED: Bridgelux Vesta Series Dim-To-Warm
Optik: Bartenbach Linse 50° UGR 15

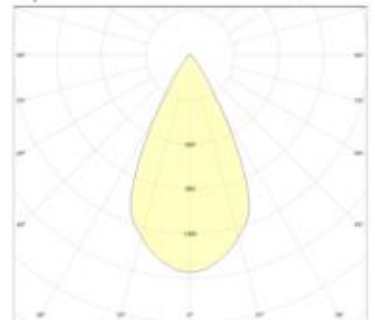

4811201

Nivo Einbauleuchte schwenkbar 111mm 50° schwarz

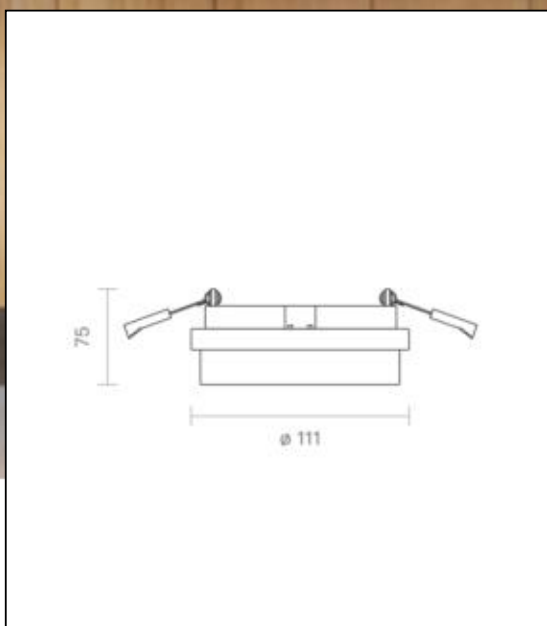

Manual:

https://shop.sigor.de/media/pdf/4811201_manual.pdf

as of: 20.03.2024

Page: 2